

**DETAIL TOOL 3"- 400PSI
(255-045)**

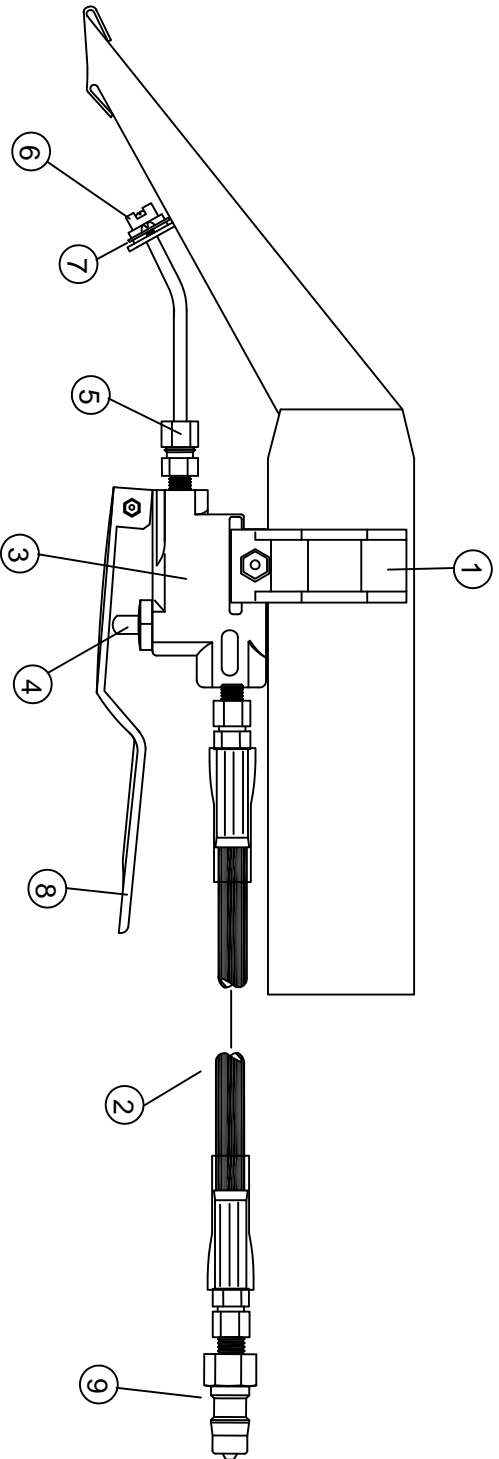

PART NO.	255-045
DATE	DEC, 14, 2004
VERSION	01

DETAILER TOOL COMPACT 3" (255-045)

REF	PART NO.	DESCRIPTION	NOTES:
1	538-212	Valve Hanger	
2	255-300	12" Whip Line	
3	535-105	Valve ASSY	
4	538-025	Valve Repair kit	
5	555-106	1/8" x 1/4" Comp Fitting	
6	562-100	Tee Jet 11002	
7	564-250	Jet Retainer Plate & Hardware	
8	566-020	Handle Detailer	
9	580-015	Q.C 1/4 Male (close)	